



Werfkasten Op Maat

www.werfkastenopmaat.be

Kempische Borden Bouw
Poeierstraat 6
B-2490 Balen
E-mail info@werfkastenopmaat.be
Tel. +32(0)14 44 32 29

Projectnummer : 202200065
Opdrachtnummer : 000030
Projectbeschrijving : Mobiele duolader 211

Klant

Eindklant

07			
06			
05			
04			
03			
02			
01			
00	16/02/2022	VBLM	TER GOEDKEURING
Ind.	Datum	Tekenaar	Omschrijving

Aantal pagina's

2



Werfkasten Op Maat
Poeierstraat 6
B-2490 BALEN

Status	TER GOEDKEURING
Revisie	00
Datum	16/03/2022
Tekenaar	VBLM

Titelblad / voorblad

202200065

Mobiele duolader 211

OP 000030

Blad

H x B x D (mm) 925 x 585 x 410

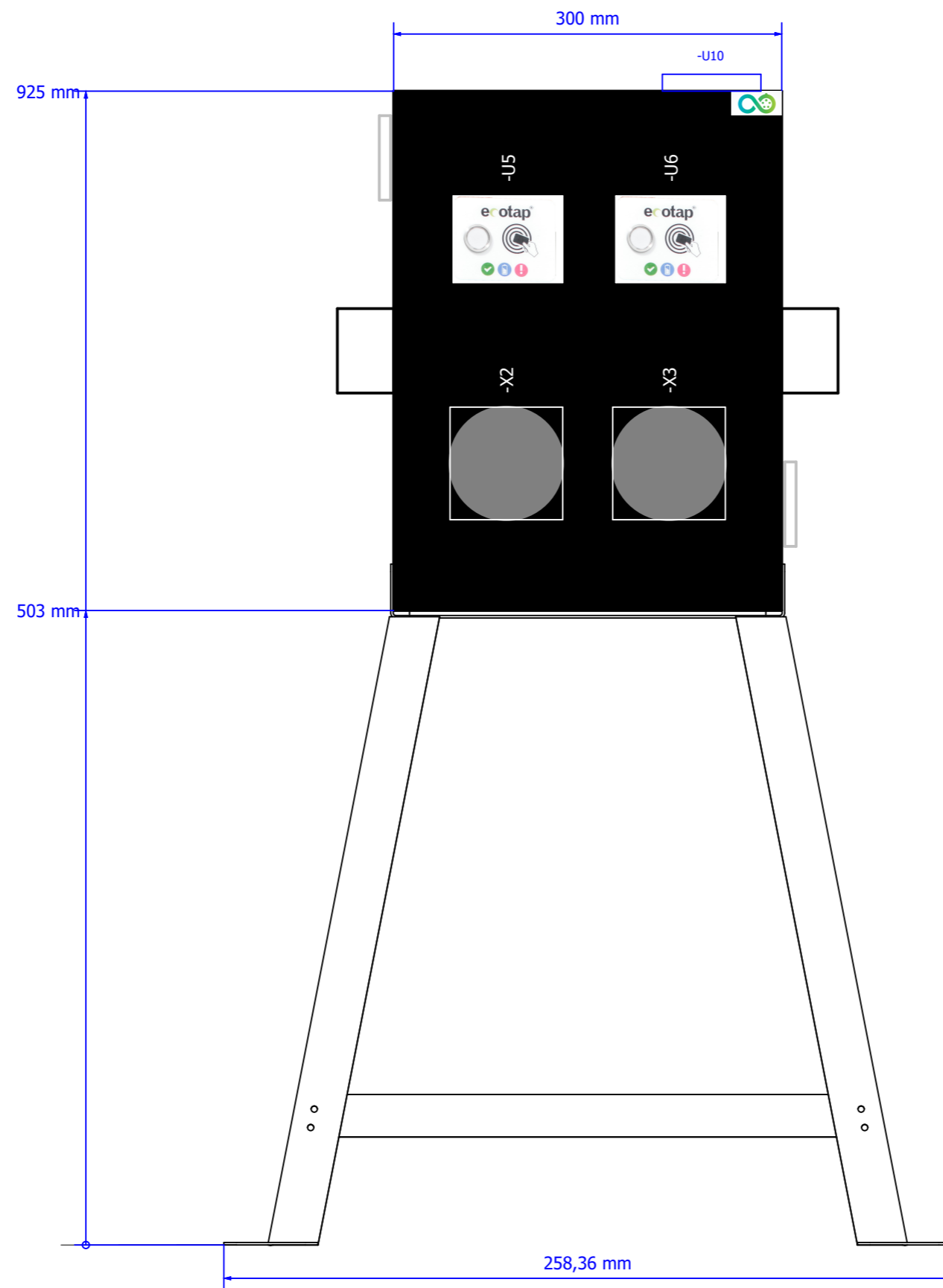

Werfkasten Op Maat
Poerstraat 6
B-2490 BALEN

Status	TER GOEDKEURING
Revisie	00
Datum	16/03/2022
Tekenaar	VBLM

Layout vooraanzicht

202200065

Mobiele duolader 211

OP 000030

Blad

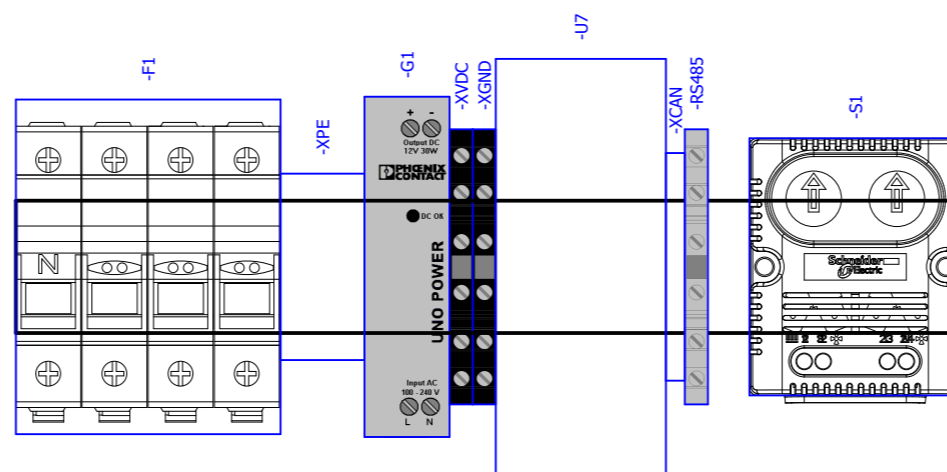
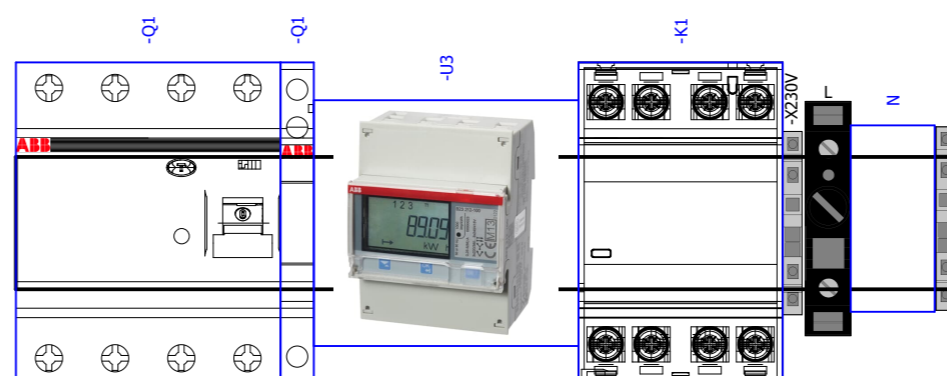
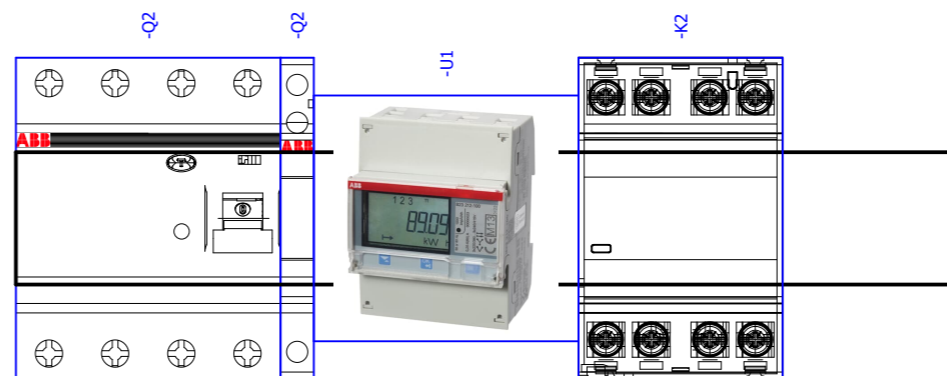

Status	TER GOEDKEURING
Revisie	00
Datum	15/03/2022
Tekenaar	VBLM

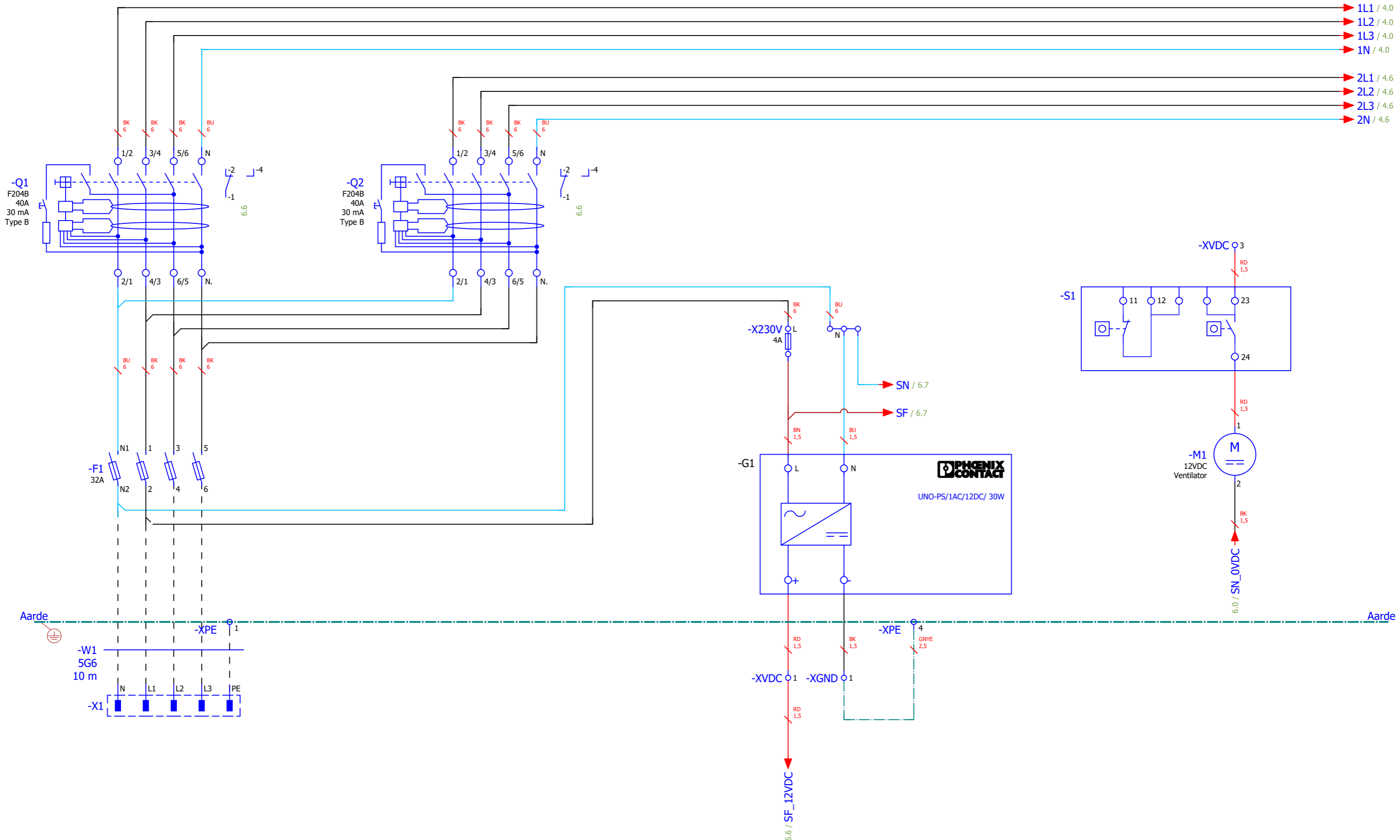

 Werfkasten Op Maat Poerstraat 6 B-2490 BALEN	Status	TER GOEDKEURING	Vermogen	202200065	Mobiele duolader 211	OP 000030
	Revisie	00				
	Datum	15/03/2022				
	Tekenaar	VBLM				
						Blad

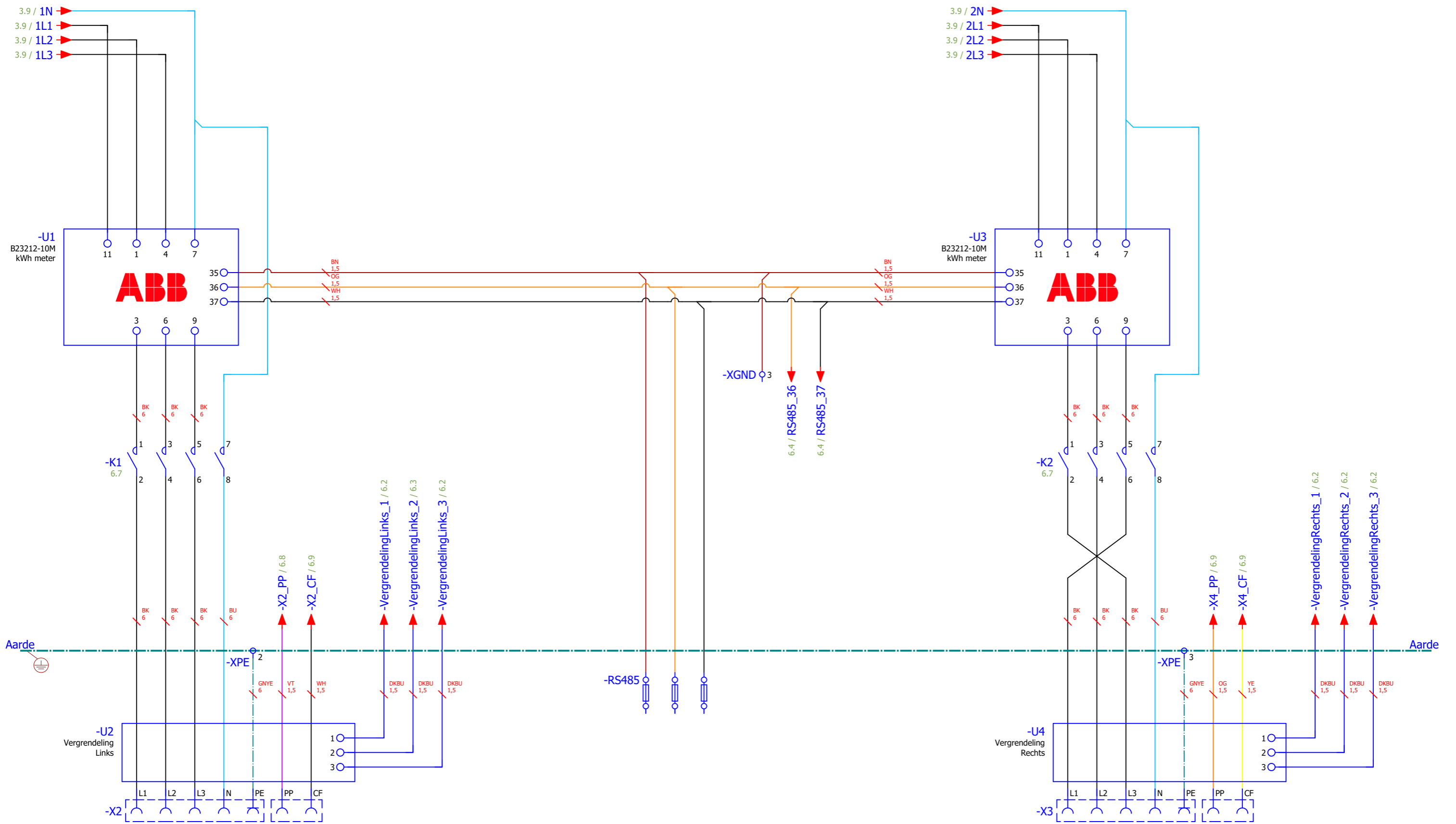

LAADPAAL
LINKS

LAADPAAL
RECHTS

-U5
Ecotap RFID
Links

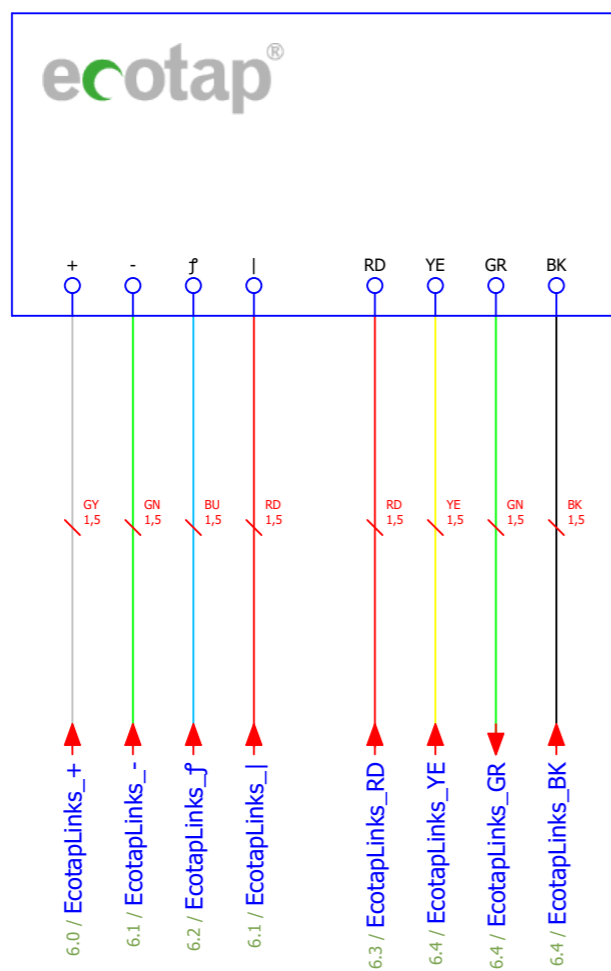

-U6
Ecotap RFID
Rechts

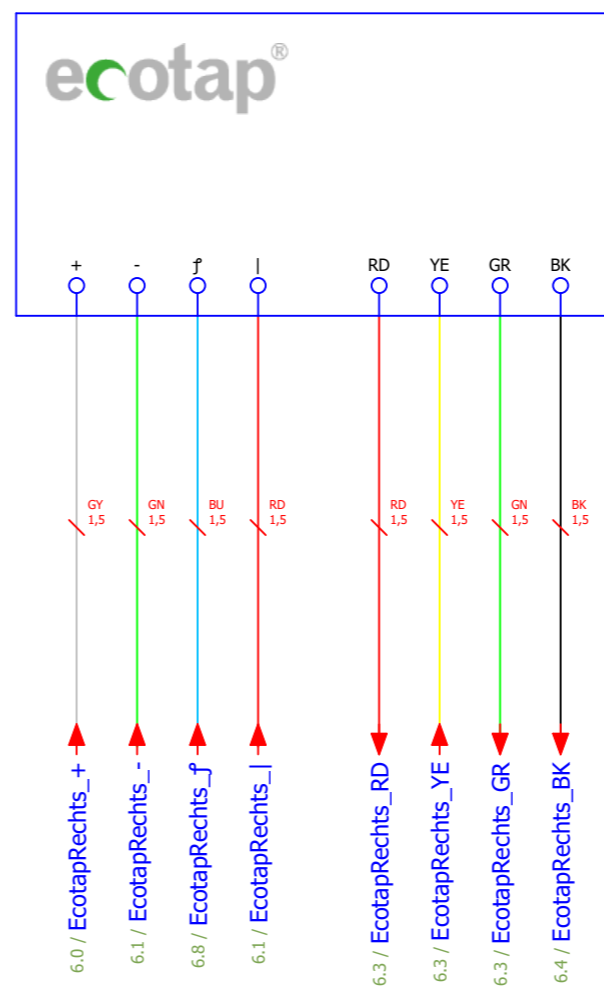

Status	TER GOEDKEURING
Revisie	00
Datum	15/03/2022
Tekenaar	VBLM

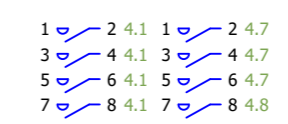
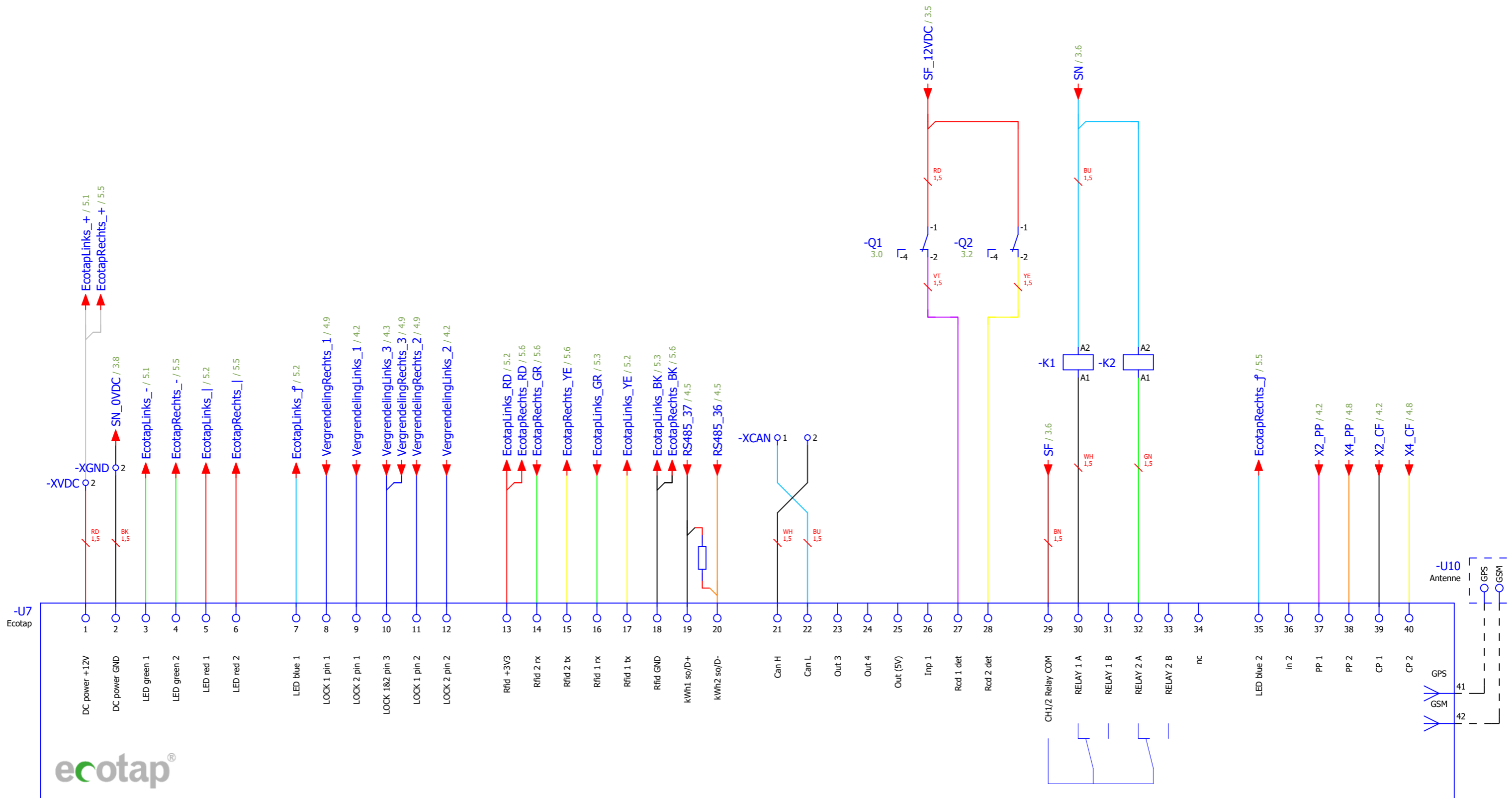

LAADPAAL LINKS
LAADPAAL RECHTS